



German Navy Westland Lynx MK.88

ドイツ海軍ウエストランド リンクス Mk.88 德国海军“山猫”MK.88

PLEASE READ BEFORE OPERATION!

- * Tools recommended as below: (Not included)
Adhesives; Paints; Side Cutters; Sharp Edged Pliers; Modeling Knife; Modeling File; Nippers; Drill; Scissors; Sand Paper; Soft Cloth; Cyanoacrylate Glue.
- * Make sure to read this instruction listed below before assembling.
- * The kit contains the small parts, they can be dangerous if swallowed by mistake, so keep them away from reach of children.
- * Cut the all parts off carefully and remove the waste parts into the garbage can.
- * More caution and care should be needed for cutting and handling the photo etched parts.
- * Make attention that some parts should be attached the decal when assembled.
- * During assembling, please tear up and throw away the plastic bags, or may cause the dangerous if wearing over head by children's mistake.
- * When using the adhesives and paints, please do not use them in the closed room or near the fire, also must be very careful to protect your eyes, face and clothes.
- * Adult supervised when assembled by children under 14 years old.

装配前请仔细阅读:

- * 推荐使用的模型工具(请自备):
专用模型胶水, 专用模型油漆, 水口剪刀, 长咀钳, 刀片, 锉刀, 镊子钳, 钻, 剪刀, 软布, 砂纸, 瞬间快干胶等。
- * 用水口剪刀或刀片小心切下所有塑胶零件和蚀刻片零件, 不要遗失小零件。
- * 切取蚀刻片时应特别注意防止利边划伤手指。
- * 用模型锉刀小心锉平所有零件表面的注射浇口。
- * 用适量的强力快干胶水粘合蚀刻片零件和金属轴, 切忌过量, 否则可能导致可动零件被粘住。
- * 注意某些零件表面需在装配时同步贴水上贴纸。
- * 制作时应远离幼儿并将包装袋及时收妥, 谨防小孩玩耍而引起意外。



cyanoacrylate glue
强力胶



weight
配重



make hole
钻孔



cut / remove
切除



option
选择



no cement
不涂胶水



decal
贴纸



bend
弯曲



repair
填补

The method to apply the decals

1. Cut off the decal from the decal paper and put it into the warm water 40°C for 10 seconds.
2. Take the decal from the water and put it on a piece of clean cloth.
3. Remove the decal slowly from the paper to the targeted location by a wet finger.
4. Use a piece of dry and soft cloth to press it gently on the decal until it getting dry and no bubble existing.

水贴纸的使用方法:

- 一. 把相关的印花从水贴纸上剪下, 放入40°C左右的温水中浸10秒。
- 二. 然后将印花放在干净的布上。
- 三. 拿上印花纸板, 手指蘸水将印花移到适当的位置。
- 四. 用软干布轻压印花直至水干, 气泡消失。

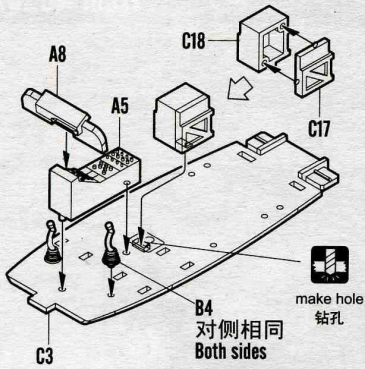

制作3组
Make three

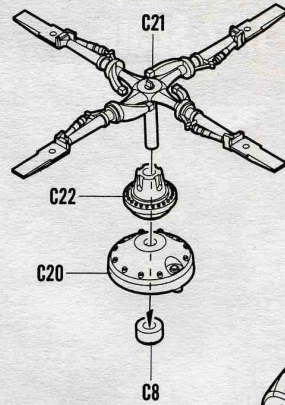
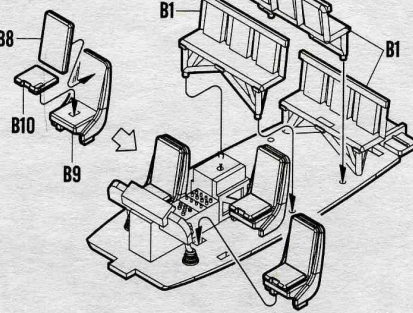

《左侧起落架》
Left undercarriage

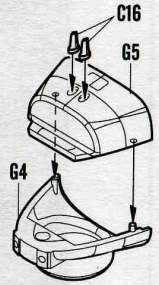
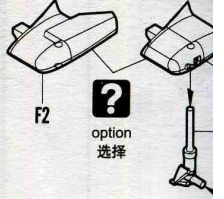

《选项选择》
option 选择

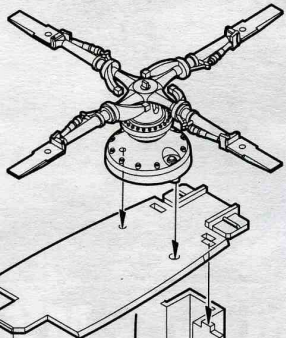

《左侧鱼雷》
Left Torpedo

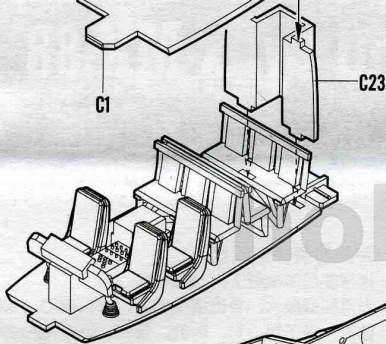

《左侧鱼雷A》
Left Torpedo A

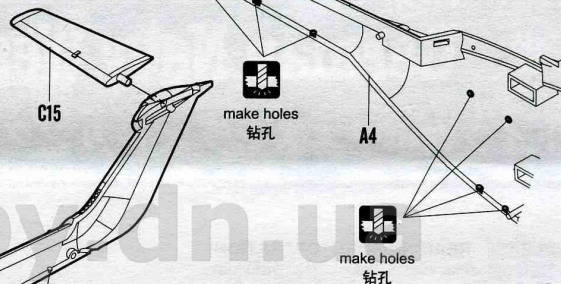

《前起落架》
Nose undercarriage

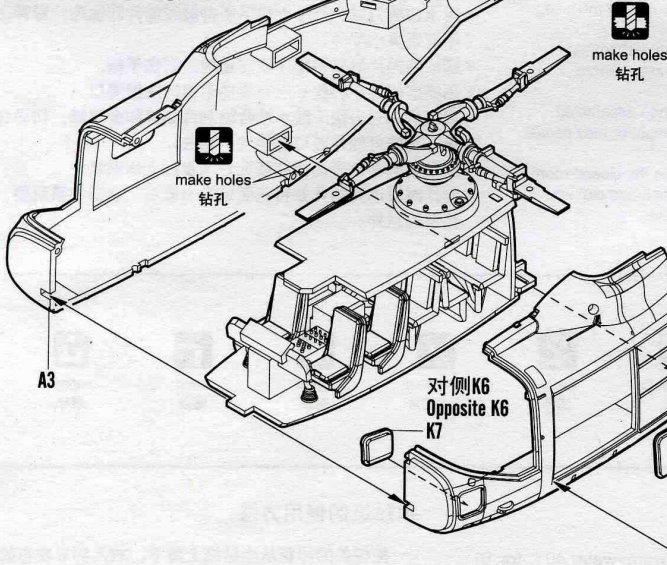

《左侧海鸥》
Left Sea Skua

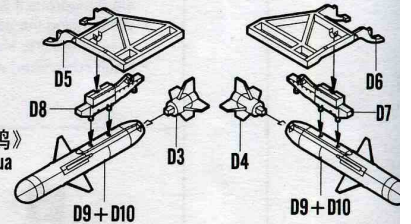

《左侧鱼雷A》
Left Torpedo A

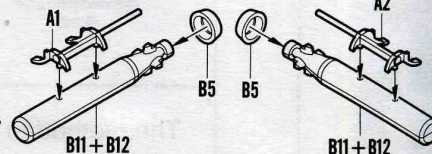

对侧K6
Opposite K6
K7

K1
对侧K2
Opposite K2

《左侧鱼雷B》
Left Torpedo B

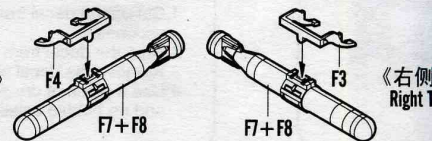

《右侧》
Right 1

C32
对侧C31
Opposite C31

部品图 Parts

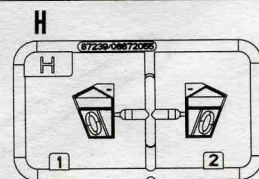
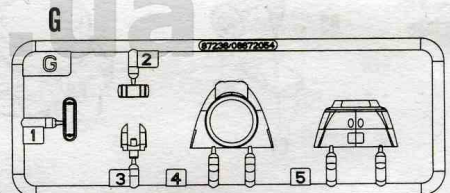
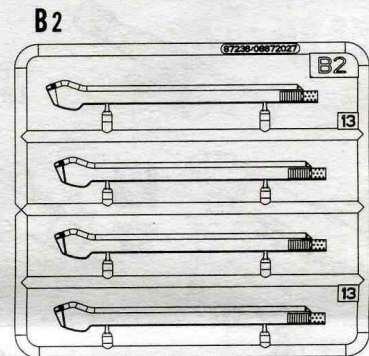
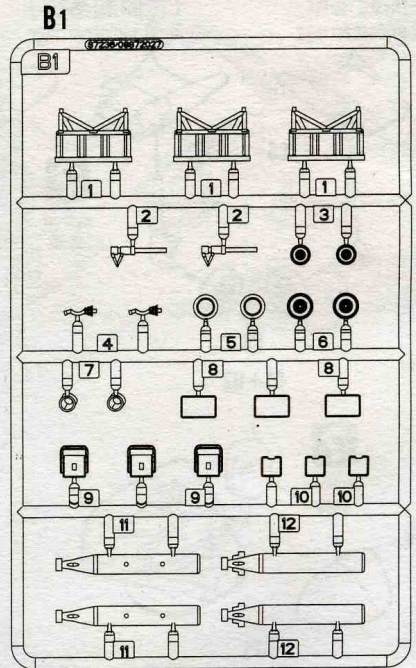
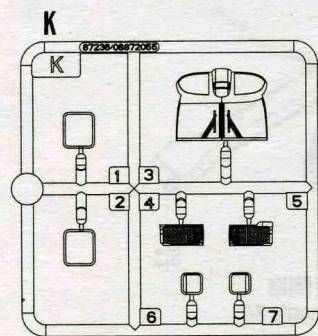
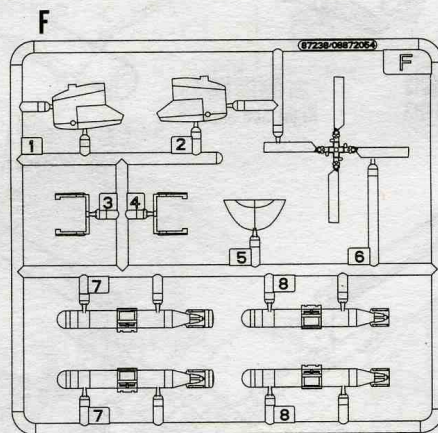
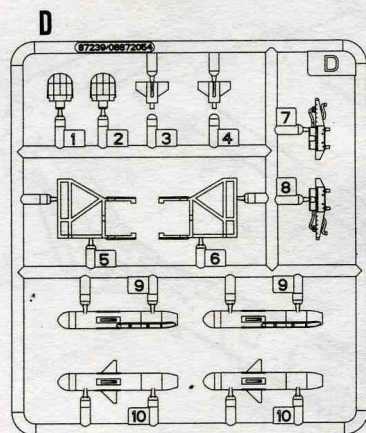
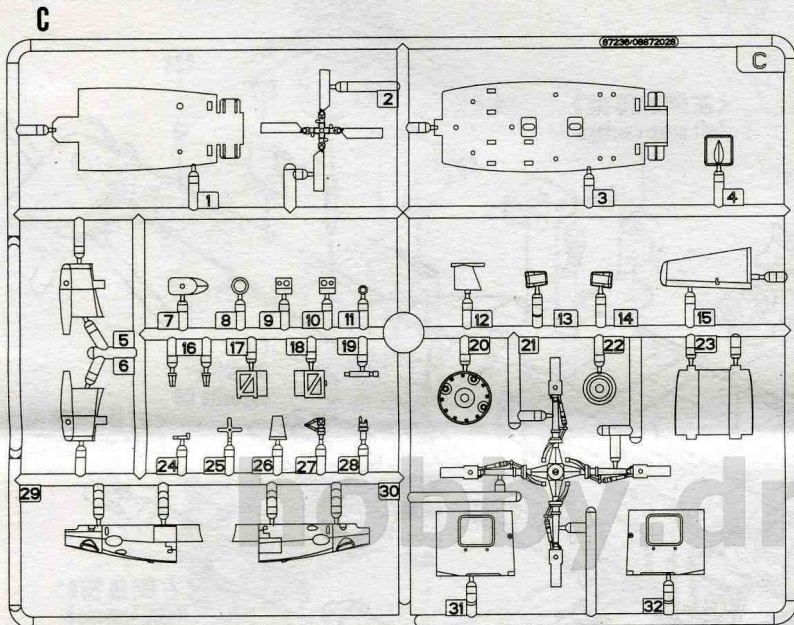
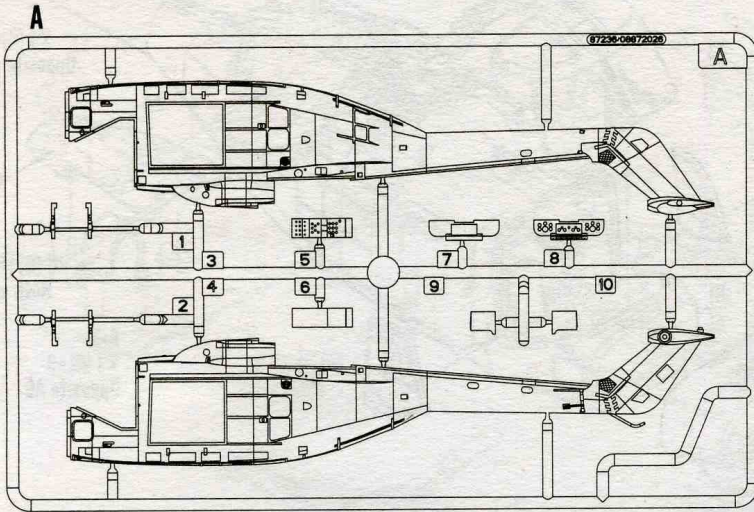

不用的零件: A6 A7 C2 G2 G3
Unused part: A6 A7 C2 G2 G3

《水贴》
Decal

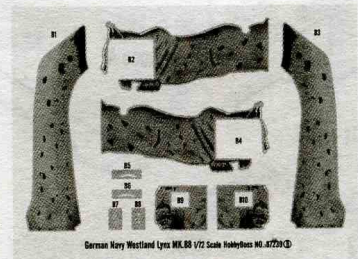
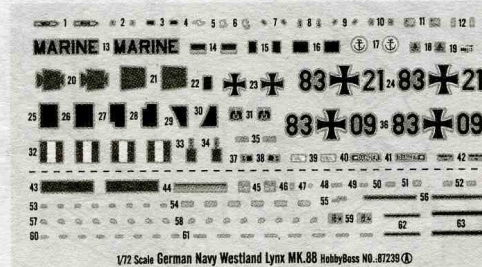

German Navy Westland Lynx MK.88 1/72 Scale HobbyBoss NO. 87239 (D)

I Westland Lynx MK.88, German Navy 83-09 Tiger Meet paint.



	Color	Mr.Hobby	Vallejo	Model Master	Tamiya	Humbrol
A	午夜蓝 Midnight Blue	H 55 71	807	--	XF17	--
B	黑色 Black	H 2 2	861	1747	X1	21
C	白色 White	H 3 3	842	1745	X2	22
D	灰色 Medium Grey	H 306 306	807	1725	XF20	--

II Westland Lynx MK.88, 83-21 German Navy.

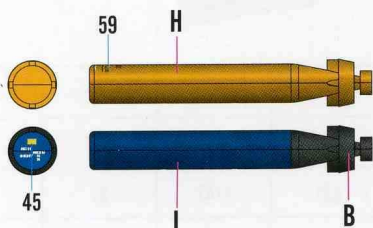

Color	Mr.Hobby	Vallejo	Model Master	Tamiya	Humbrol
E 红色 RED	H 3 3	908	1503	X7	19
F 灰色 Gray	H 308 308	990	1728	XF19	127
G 蓝色 Blue	H 328 328	--	1772	--	190
H 透明橙 Clear Orange	H 92 49	935	--	X26	--
I 蓝色 Blue	H 5 5	899	1772	X3	15